



CLASSEN®

CATALOGUE

SKIRTING BOARDS

2024



6		THE 80TH
20		CASAline
26		CLIP
36		PURE+WHITE
46		BASE PRO UNDERLAYS
52		ADDITIONAL ASSEMBLY PRODUCTS
53		DIGITAL BASE HELPFUL MATERIALS
54		GUIDELINES HELPFUL MATERIALS
55		INSTALLATION



HDF/MDF SKIRTING BOARDS ARE A PERFECT EXAMPLE OF HOW YOU CAN COMBINE AESTHETICS AND ECOLOGY

Thanks to their beautiful appearance and materials that use recycled wood, they are an excellent solution both visually and ecologically.

These are skirtings that contribute to environmental protection while offering high quality and style. Additionally, each moulding has ecological certificates, which proves their environmental friendliness and gives us confidence that the selected product meets high quality standards.

THE 80TH



A BEAUTY INSPIRED BY NATURE, REFLECTING THE NATURE OF NATURAL WOOD

Experience acquired over the years and meticulous work on the selection of colors, such a combination creates the 80-th skirting board in its tasteful and elegant dimension.

Durability Redefined: Engineered using high-quality HDF, our skirting boards stand the test of time.

Resistant to warping, moisture, and wear, they maintain their integrity, providing long-lasting elegance for years to come.



TECHNICAL DATA

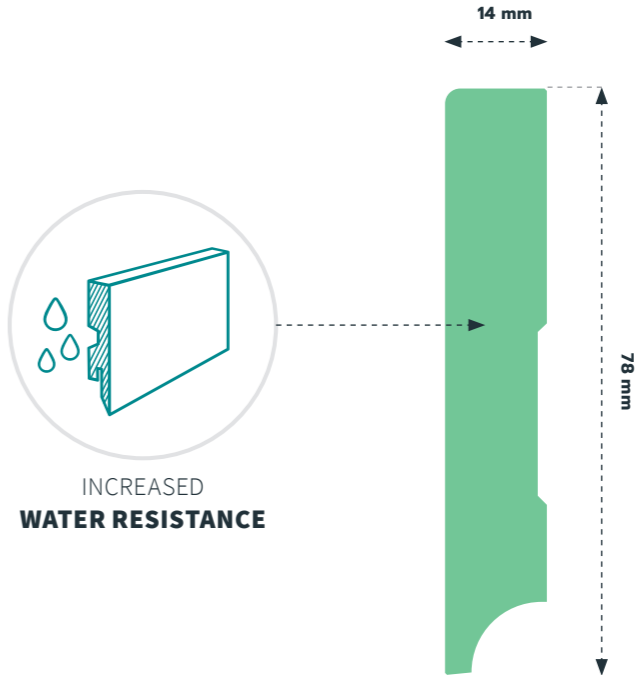

LOGISTIC DATA:

1 PCS (mm)	NET WEIGHT 1 pcs. (kg)	BOX quantity in package	DIMENSIONS	GROSS WEIGHT box(kg)	PALETTE quantity in palette	DIMENSIONS	GROSS WEIGHT palette (kg)
78x14x2400	1,99	5	76x85x2430	10,691	405	864x800x2430	866



L3750
57484



L3882
57485



L3676
57486



L738
57493



D6125
57494



L3897
57495



D4193
57487



L733
57488



L3794
57489



L3667
57496



L881/ L3838
57497



L3682
57498



L3674
57490



L740
57491



L3666
57492



L3655
57499



D6148
57500



D6283
57501



L749
57502



L3668
57503



L3672
57504



L3989
57512



L3637
57513

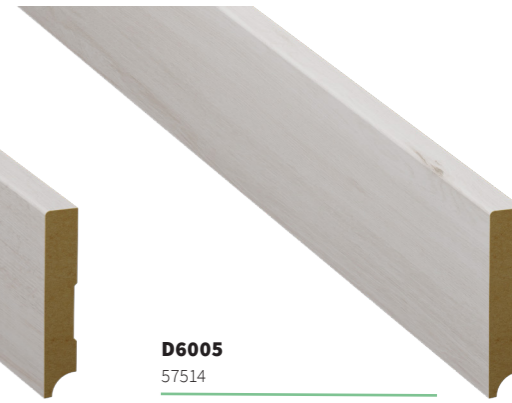

D6005
57514



L3809
57505



L3670
57506



L3842
57508



L3905
57515



D6399
57516



L3675
57517



L3863
57509



L3731
57510



D6398
57511



L3985
57518



L3810
57519

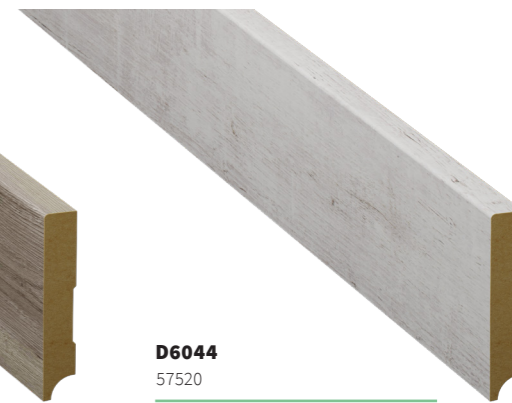

D6044
57520



D4509
57521



L3751
57522



D6452
57523



L3942
57530



L3939
57531



L3936
57532



L3891
57524



D6446
57525



D6425
57526



D6448
57533



L3938
57534



L3945
57535



L3937
57527



D6453
57528



D6430
57529



L3944
57536



L3898
57537



L3890
57538



L3940
57539



L3943
57540



L3941
57541



D6440
57549



L3988
57550



D6419
57551



L3862
57542



D6449
57543



D6436
57545



D6401
57552



D6429
57553



D6438
57554



D6427
57546



D6402
57547



L3902
57548



D6439
57555



L3991
57556



D6431
57557



D6397
57558



D6407
57559



L3986
57560



D6433
63082



L3900
63083



L4055
63390



D6441
57562



D6426
57563



D6400
57564



WHITE
62924

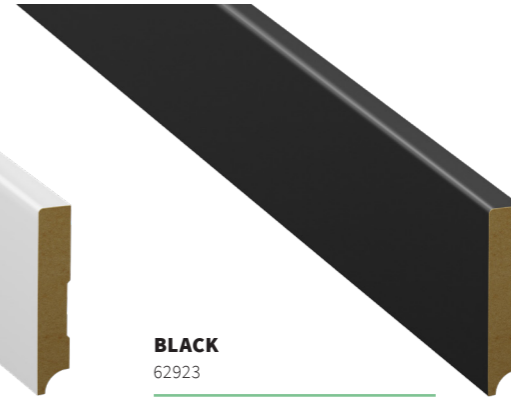

BLACK
62923



D6435
57565



D6110
57566



D3838
63081

CASAline



ELEVATE YOUR SPACE WITH OUR EXCLUSIVE MDF SKIRTING BOARD COLLECTION

A fusion of classic charm and contemporary precision.

Immerse yourself in a world where design meets durability, curated to perfection for seamless integration into any interior.



TECHNICAL DATA

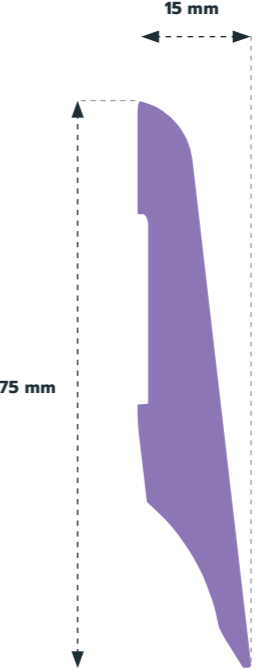

LOGISTIC DATA:

1 PCS (mm)	NET WEIGHT 1 pcs. (kg)	BOX quantity in package	DIMENSIONS	GROSS WEIGHT box (kg)	PALETTE quantity in palette	DIMENSIONS	GROSS WEIGHT palette (kg)
75x15x2400	1,16	10	65x134x2410	12,17	450	750x800x2430	548



L3940
62338



L3682
62340



L3731
62341



L3902
62363



D6429
62365

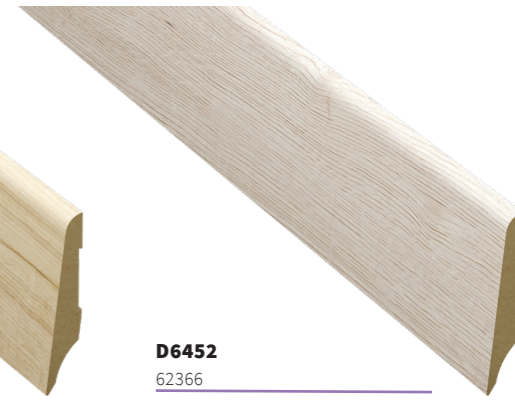

D6452
62366



D6427
62346



D6125
62347



D6436
62349



L3897
62367



D6005
62368

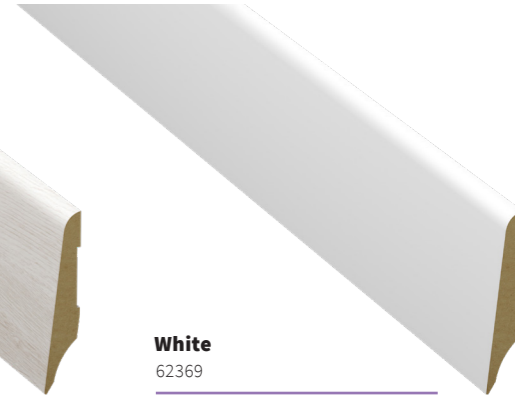

White
62369



D6419
62358



D6426
62360



D6435
62362



Black
62370



Silver
62371

CLIP

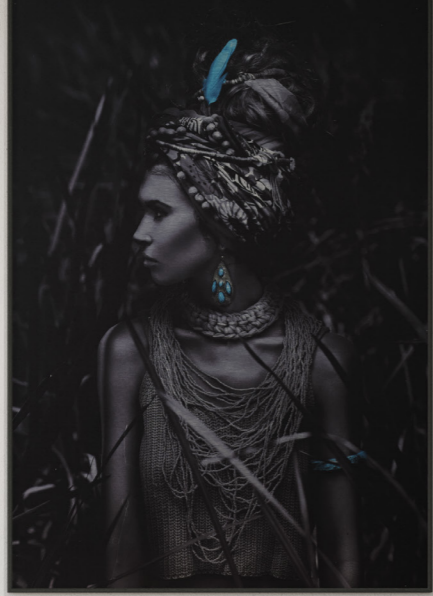

CLIP COLLECTION IS RESULTS OF METICULOUS CRAFTSMANSHIP

Every skirting board is a testament to our unwavering commitment to precision.

Crafted with care, our MDF collection ensures flawless profiles and smooth finishes that redefine sophistication.





TECHNICAL DATA

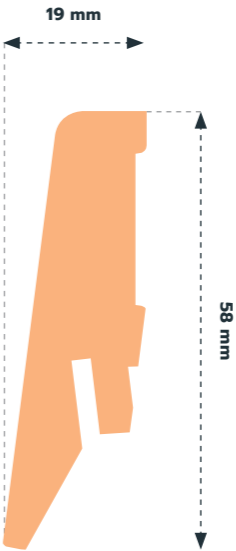

LOGISTIC DATA:

1 PCS (mm)	NET WEIGHT 1 pcs. (kg)	BOX quantity in package	DIMENSIONS	GROSS WEIGHT (kg)	PALETTE quantity in palette	DIMENSIONS	GROSS WEIGHT palette (kg)
58x19x2400	1,02	10W	75x105x2410	10,75	560	750x800x2450	602



White
31832



L512
32511



L278
32516



L845
45566



L254
57204



L264
57205



D379
33043



L530
33044



D6005
36345



L572
57206



L373
57207



L848
57208



D378
42817



L3731
42822



L240
42832



L412
57209



L3674
57210



D575
57211



L1038
57212



L520
57213



L664
57215



L301
57216



L3638
57217



L3739
57218



L3655
57219



L782
57220



L3658
57221



63393 - Clip L3754



L3637
57222



L663
57223



L3635
57224



L3758
63394

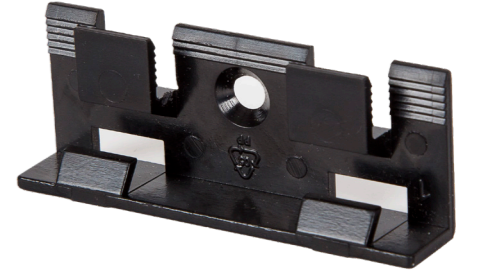

31857



D3637
57225



D6435_194
63197



L3905
63198



L4037
63388



L4055
63392



L3754
63393

PURE

+WHITE



PURE+ WHITE SKIRTING BOARD COLLECTION – VERSATILE STYLES

Explore a diverse range of styles, from minimalist designs to intricate detailing, allowing you to express your unique aesthetic.

Our collection seamlessly adapts to various interior themes, making it the perfect choice for any space.

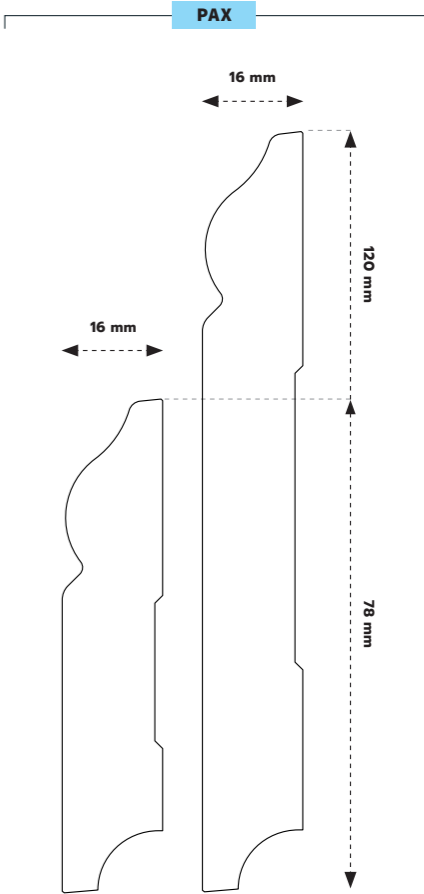
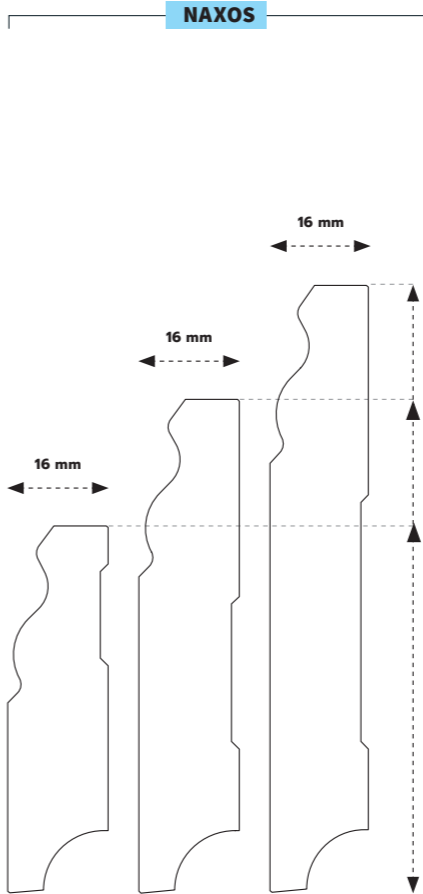
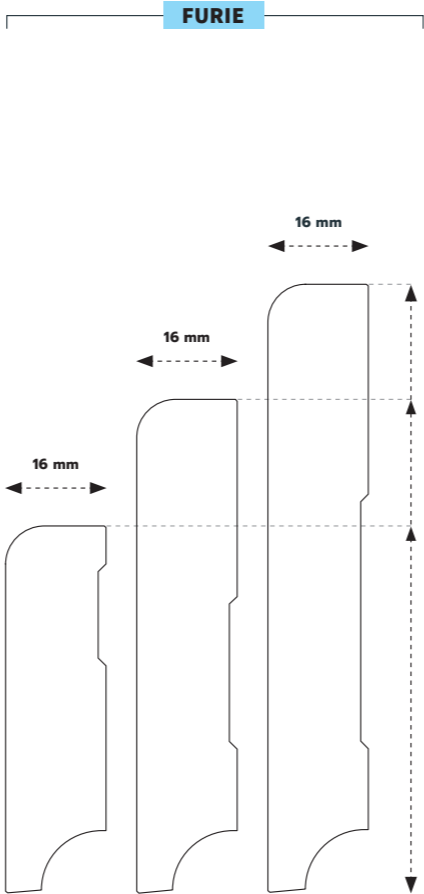
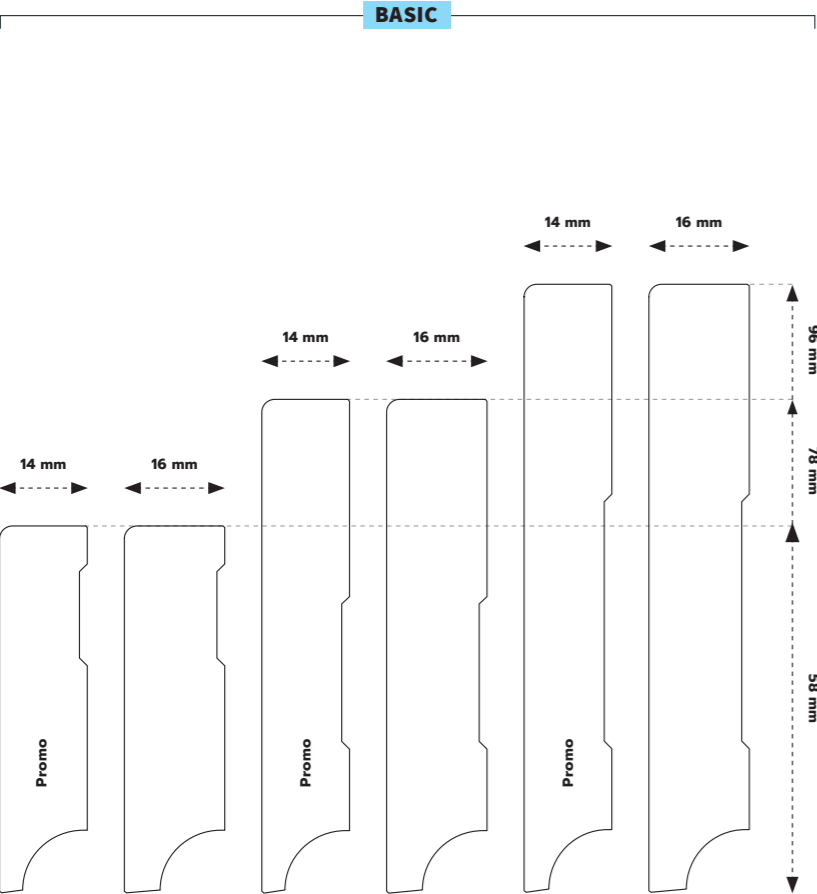

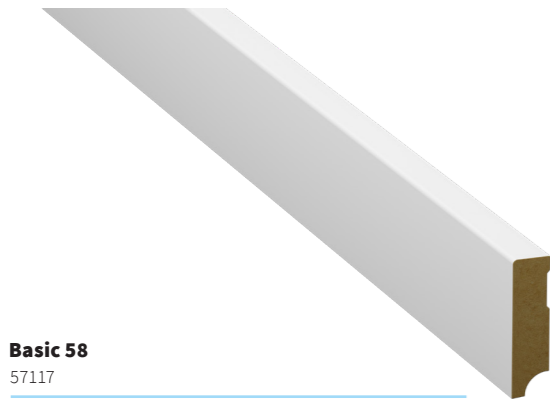

Basic 58
57117

LOGISTIC DATA	QUANTITY in package	DIMENSIONS	GROSS WEIGHT (kg)
PIECE (mm)	1	58x16x2400	1,38 (net weight)
BOX quantity in box	10	85x105x2410	14,76
PALETTE quantity in palette	490	775x800x2450	723



Naxos 58
57122

LOGISTIC DATA	QUANTITY in package	DIMENSIONS	GROSS WEIGHT (kg)
PIECE (mm)	1	58x16x2400	1,17 (net weight)
BOX quantity in box	10	85x105x2410	12,55
PALETTE quantity in palette	490	775x800x2450	615



Basic 78
57120

LOGISTIC DATA	QUANTITY in package	DIMENSIONS	GROSS WEIGHT (kg)
PIECE (mm)	1	78x16x2400	1,92 (net weight)
BOX quantity in box	5	85x85x2410	10,35
PALETTE quantity in palette	315	775x800x2450	652



Naxos 78
57123

LOGISTIC DATA	QUANTITY in package	DIMENSIONS	GROSS WEIGHT (kg)
PIECE (mm)	1	58x16x2400	1,17 (net weight)
BOX quantity in box	10	85x105x2410	12,55
PALETTE quantity in palette	490	775x800x2450	615

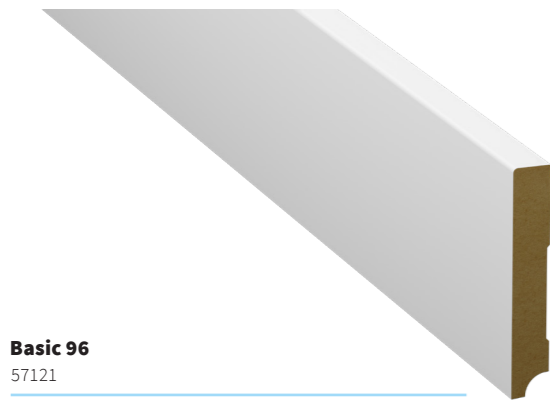

Basic 96
57121

LOGISTIC DATA	QUANTITY in package	DIMENSIONS	GROSS WEIGHT (kg)
PIECE (mm)	1	96x16x2400	2,29 (net weight)
BOX quantity in box	5	85x102x2410	12,35
PALETTE quantity in palette	245	775x800x2450	605

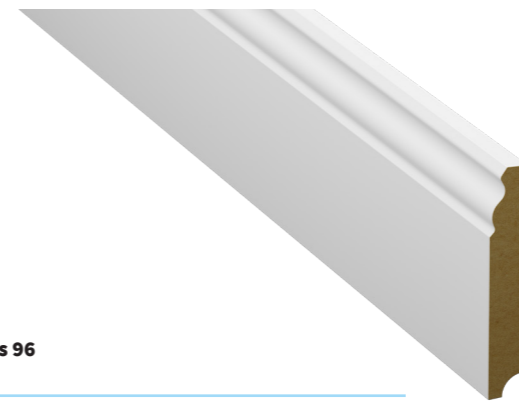

Naxos 96
57124

LOGISTIC DATA	QUANTITY in package	DIMENSIONS	GROSS WEIGHT (kg)
PIECE (mm)	1	96x16x2400	2,10 (net weight)
BOX quantity in box	5	85x102x2410	11,33
PALETTE quantity in palette	245	775x800x2450	615

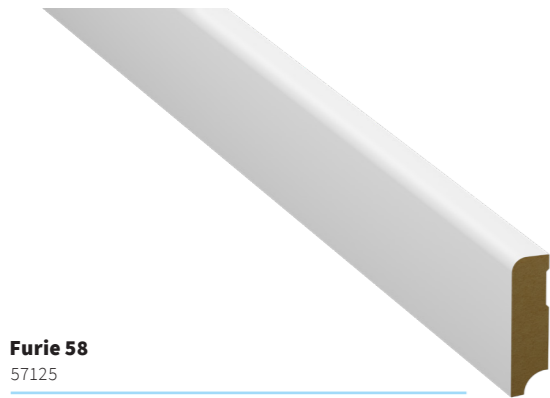

Furie 58
57125

LOGISTIC DATA	QUANTITY in package	DIMENSIONS	GROSS WEIGHT (kg)
PIECE (mm)	1	58x16x2400	1,36 (net weight)
BOX quantity in box	10	85x105x2410	14,57
PALETTE quantity in palette	490	775x800x2450	714



Furie 78
57126

LOGISTIC DATA	QUANTITY in package	DIMENSIONS	GROSS WEIGHT (kg)
PIECE (mm)	1	78x16x2400	1,83 (net weight)
BOX quantity in box	5	85x85x2410	9,83
PALETTE quantity in palette	315	775x800x2450	619

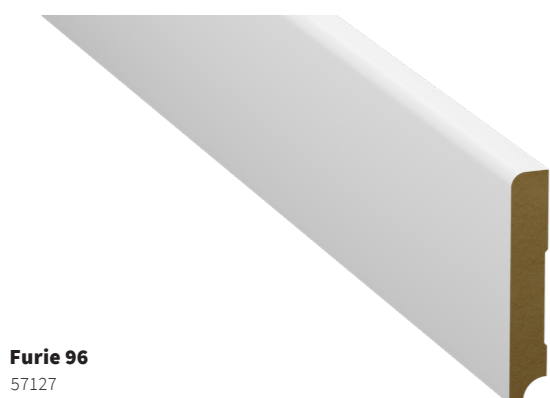

Furie 96
57127

LOGISTIC DATA	QUANTITY in package	DIMENSIONS	GROSS WEIGHT (kg)
PIECE (mm)	1	96x16x2400	2,34 (net weight)
BOX quantity in box	5	85x102x2410	12,57
PALETTE quantity in palette	245	775x800x2450	616



57126 - Furie 78

Pax 78
57128

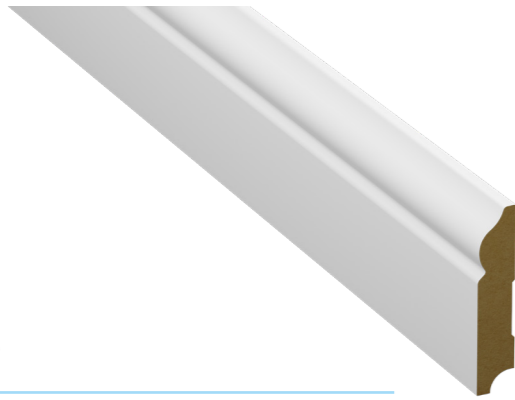

LOGISTIC DATA	QUANTITY in package	DIMENSIONS	GROSS WEIGHT (kg)
PIECE (mm)	1	78x16x2400	1,70 (net weight)
BOX quantity in box	5	85x85x2410	9,14
PALETTE quantity in palette	315	775x800x2450	576

Basic Promo 58
57130

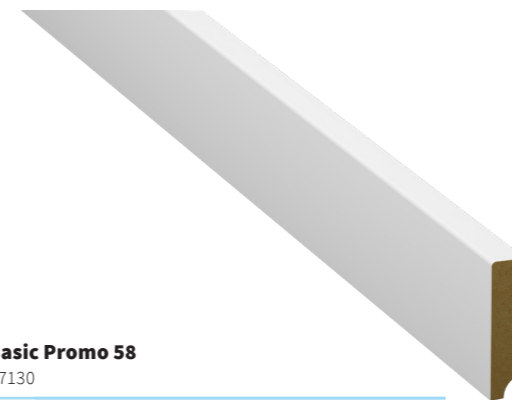

LOGISTIC DATA	QUANTITY in package	DIMENSIONS	GROSS WEIGHT (kg)
PIECE (mm)	1	58x14x2400	1,26 (net weight)
BOX quantity in box	10	75x121x2410	13,56
PALETTE quantity in palette	540	855x800x2450	732

Pax 120
57129

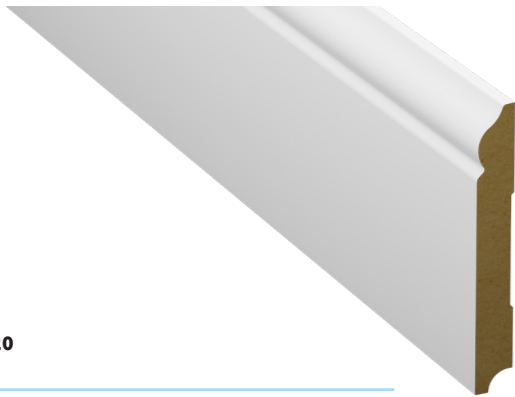

LOGISTIC DATA	QUANTITY in package	DIMENSIONS	GROSS WEIGHT (kg)
PIECE (mm)	1	120x16x2400	2,81 (net weight)
BOX quantity in box	5	85x127x2410	15,12
PALETTE quantity in palette	210	690x800x2450	635

Basic Promo 78
57131

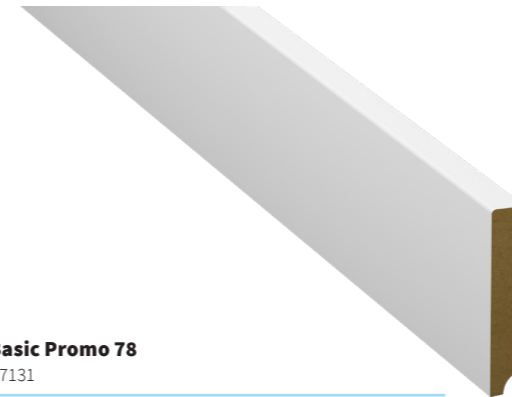

LOGISTIC DATA	QUANTITY in package	DIMENSIONS	GROSS WEIGHT (kg)
PIECE (mm)	1	78x14x2400	1,64 (net weight)
BOX quantity in box	6	76x85x2410	8,80
PALETTE quantity in palette	405	864x800x2450	713

Basic Promo 70
62337

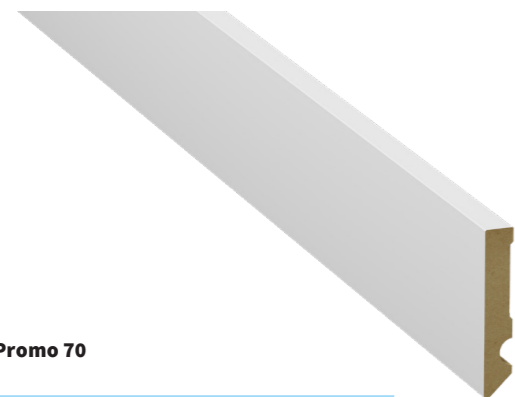

LOGISTIC DATA	QUANTITY in package	DIMENSIONS	GROSS WEIGHT (kg)
PIECE (mm)	1	70x12x2400	1,19 (net weight)
BOX quantity in box	10	62x147x2410	12,3
PALETTE quantity in palette	400	676x800x2450	492

Basic Promo 96
57132

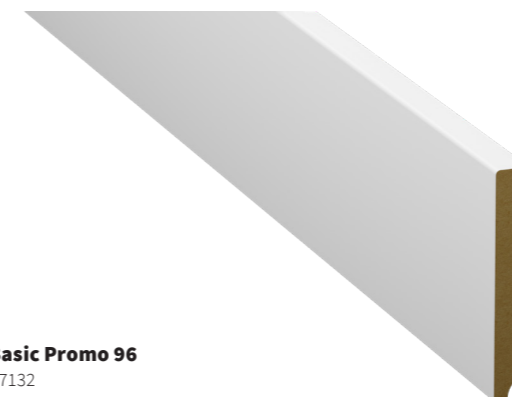

LOGISTIC DATA	QUANTITY in package	DIMENSIONS	GROSS WEIGHT (kg)
PIECE (mm)	1	96x14x2400	2,00 (net weight)
BOX quantity in box	6	90x102x2410	12,88
PALETTE quantity in palette	245	810x800x2450	631







BASE PRO

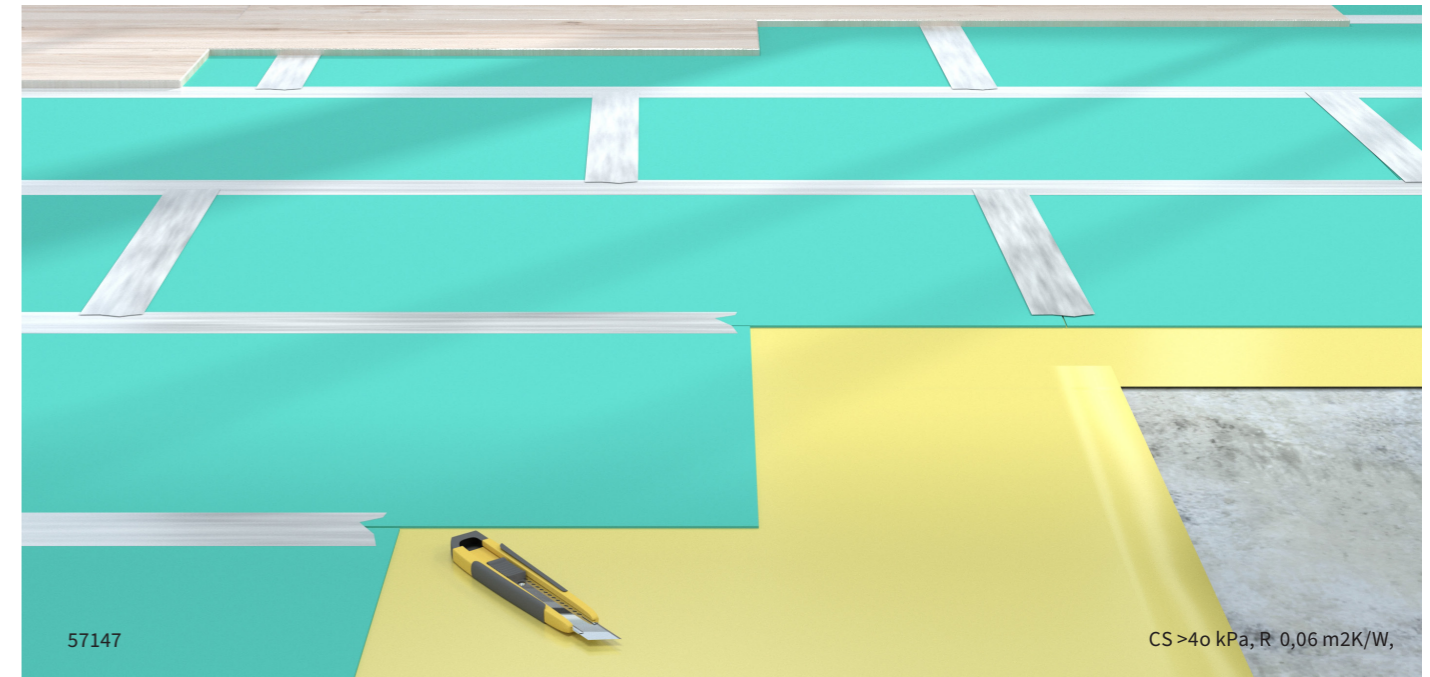



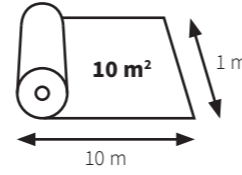

UNDERLAYS

**FLOOR UNDERLAYS ARE
A KEY ELEMENT THAT
AFFECTS THE COMFORT OF
USE, BUT ALSO PROTECTS
AND EXTENDS THE LIFE
OF THE ENTIRE FLOOR**

The key parameters of the underlay are: sound absorption, thermal insulation, protection against moisture, leveling unevenness.



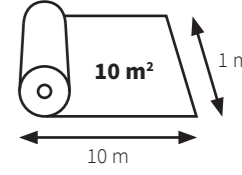

-  For heated floors
-  Simple to fix
-  Levelling of the base
-  Acoustic insulation
-  Perfect for Ceramin floors
-  Perfect for Herringbone floors
-  10 m²
10 m x 1 m

-  For heated floors
-  Simple to fix
-  Levelling of the base
-  Acoustic insulation
-  Perfect for Ceramin floors
-  Perfect for Herringbone floors
-  10 m²
10 m x 1 m

LOGISTIC DATA	QUANTITY (m²)	DIMENSIONS (mm)	GROSS WEIGHT (kg)
1 ROLL	10	1,5x1000x10000	13,5
1 PALETTE	400	1280x800x1200	540

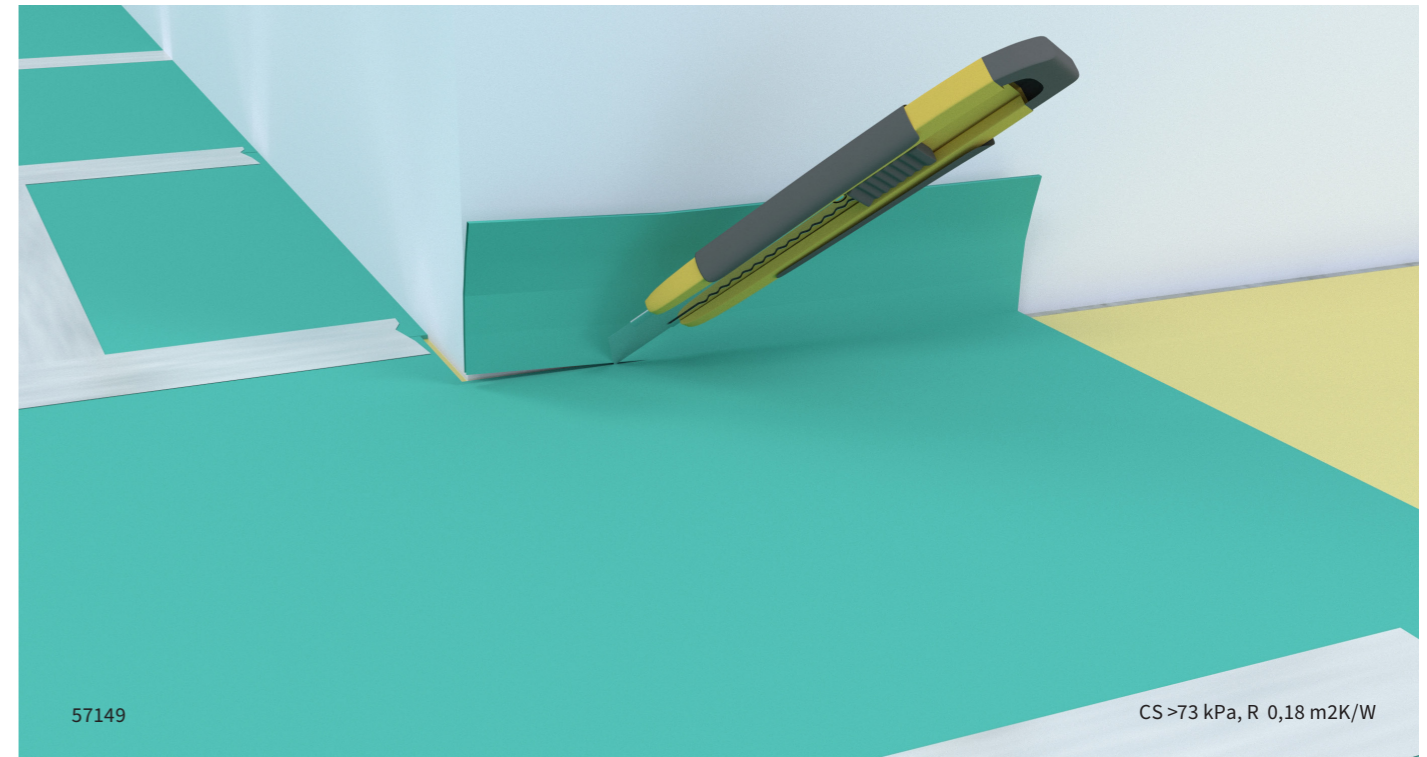
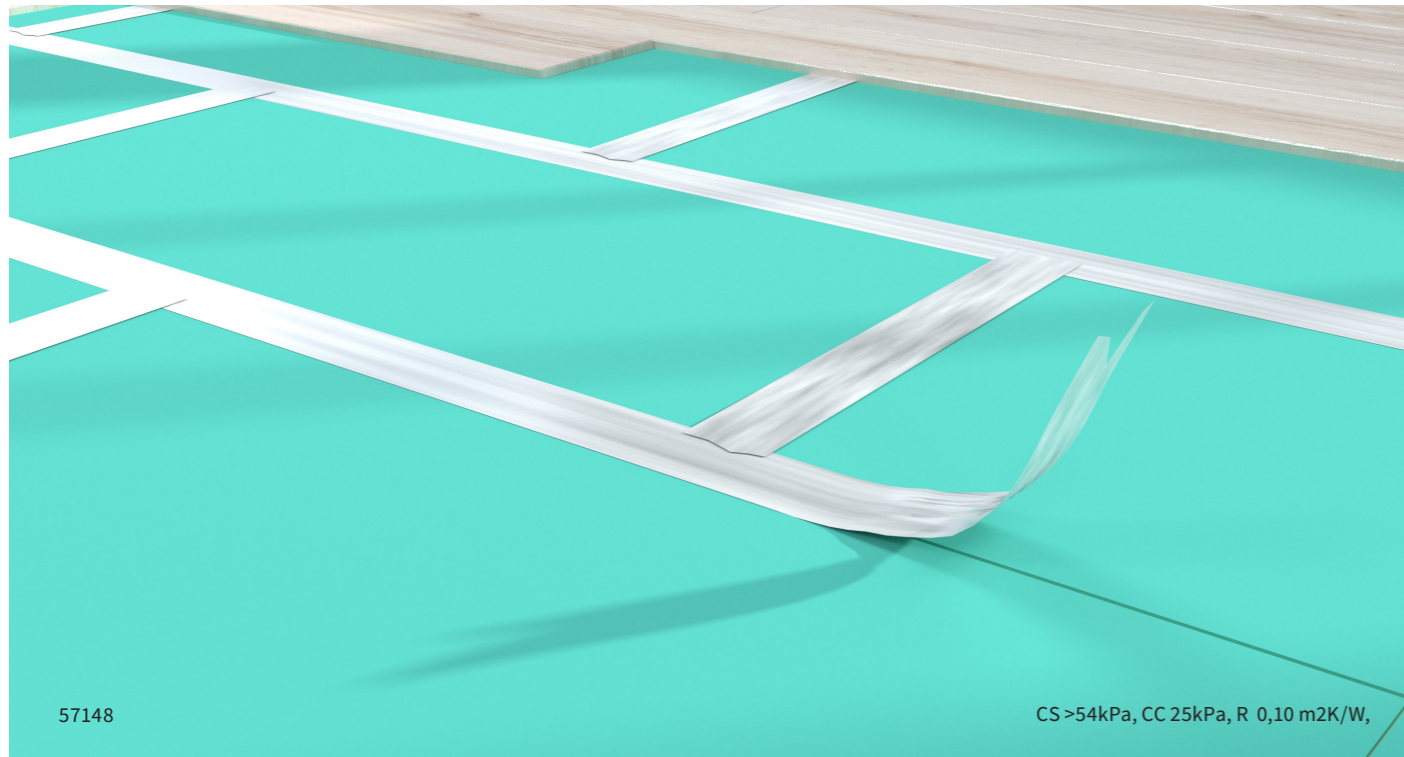
LOGISTIC DATA	QUANTITY (m²)	DIMENSIONS (mm)	GROSS WEIGHT (kg)
1 PIECE	0,5	2x500x1000	0,038
1 PACK	8	32x500x1000	0,64
1 BOX	136	600x505x1010	10,88
1 PALETTE	1088	1280x1000x2020	87







Simple to fix



Levelling of the base



Acoustic insulation



Perfect for Ceramin floors



Perfect for Herringbone floors

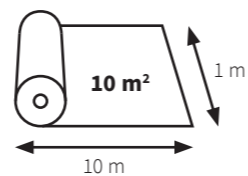





Simple to fix



Levelling of the base



Acoustic insulation



Perfect for Ceramin floors



Perfect for Herringbone floors

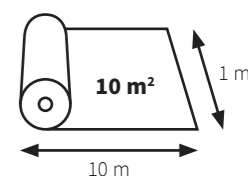

LOGISTIC DATA	QUANTITY (m ²)	DIMENSIONS (mm)	GROSS WEIGHT (kg)
1 PIECE	0,5	3x500x1000	0,0425
1 PACK	5	30x500x1000	0,425
1 PALETTE	1088	1280x1000x2020	68

LOGISTIC DATA	QUANTITY (m ²)	DIMENSIONS (mm)	GROSS WEIGHT (kg)
1 PIECE	0,5	5x500x1000	0,0725
1 PACK	5	50x500x1000	0,725
1 PALETTE	1088	1280x1000x2020	72

ADDITIONAL

ASSEMBLY PRODUCTS



Classen Multi-Connect glue
15 kg



Glue spreader
B1 180 mm



Ceramin finishing profile
3 x 2500 mm



Classen Multi-Connect glue
5,5 kg



Glue spreader
B3 180 mm



Dilatation cord
6 mm / 10 mb.



Classen Multi-Connect glue
Tube 290 ml



Glue spreader
C1 180 mm



Dilatation cord
10 mm / 12 mb.

DIGITAL BASE

HELPFUL MATERIALS



Classen Floor website



Classen Competence Centre



Classen Cloud



Download section



Skirtings collections



Technical Data Sheet



YouTube tips videos



How to install skirtings



Ending of skirtings

GUIDELINES

HELPFUL MATERIALS

GUIDELINES FOR STORING AND INSTALLING BOARDS

Storage

It is important to store the skirtings in their original packaging in a room with a relative humidity of 45-65% and a temperature of 18-22°C, avoiding direct contact with the floor by placing them on an insulating layer such as a pallet, Styrofoam or cardboard.

Assembly

Before installation, the skirtings should be acclimatized in the room where they will be installed for at least 24 hours. In the room, it is important to measure the wall humidity and paint adhesion test, and the skirtings should be checked for possible defects and damage. Installation should be done using an appropriate base glue, eg. Mamut Clue by Den Braven, and a thermo-melt glue that attaches the skirtings to the wall until the base glue is fully set. Installation of the skirtings should include connecting them tightly together, and additional security measures, such as sealing the joints and the upper edge of the moulding, are equally important.

It is not recommended to use sealing compounds at the joint between the skirting and the floor made in the floating system.

The installer is responsible for any defects occurring during installation. Do not install skirtings with damage as this may void the warranty and the responsibility for the situation is transferred to the installer or buyer.

Maintenance

Maintenance of skirting boards should be regular, regular including sealing cracks and gaps with acrylic. Before installation in specific rooms, such as a bathroom or kitchen, it is necessary to check the humidity and temperature conditions. In humid rooms. It is recommended to use skirtings with increased moisture resistance with an HDF core, but their use in places at risk of flooding with water is excluded.

Exploitation

During operation. MDF/HDF skirting boards require that the air temperature and humidity be maintained at 18-22 °C and 40-60%, respectively.

When washing the floor, avoid water getting under the skirting and clean with a damp cloth.

Underfloor heating may affect the skirtings, so you should monitor their condition and if necessary, fill the gaps with acrylic. Changing the color of the moulding coating during use is a natural phenomenon, especially under the influence of sunlight.

However, remember to use it responsibly, bearing in mind that MDF skirtings are sensitive to moisture and require appropriate climatic conditions.

The manufacturer is not liable for defects resulting from incorrect installation or operation in accordance with specified conditions.

Manufacturer's liability

The manufacturer is not liable for defects resulting from improper installation or operation of the product, in particular for:

- product detaching from the wall due to incorrect installation
- product damage resulting from structural defects in the rooms, i.e. poor wall insulation and/or leaky windows and doors
- mechanical damage and defects resulting from them
- damage to the product resulting from flooding it with water or moisture
- defects resulting from normal wear and tear of the product, including natural color change due to sunlight
- defects resulting from failure to maintain appropriate climatic conditions throughout the life of the product.

INSTALLATION

CLIP ASSEMBLY

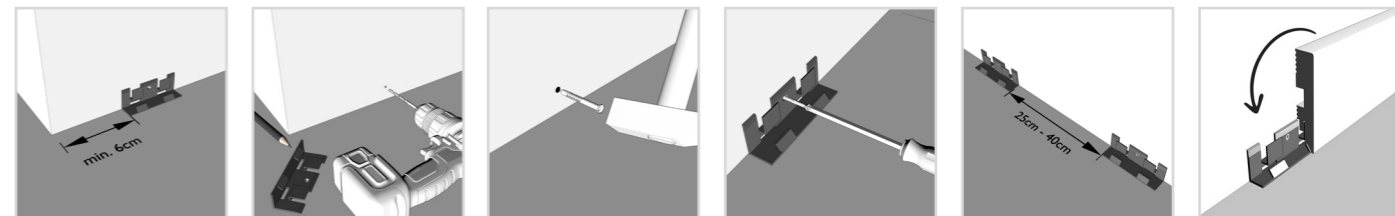

GLUE ASSEMBLY

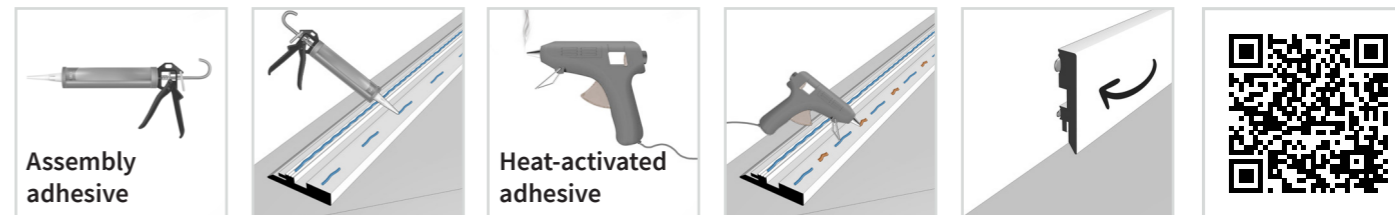

FINISHING

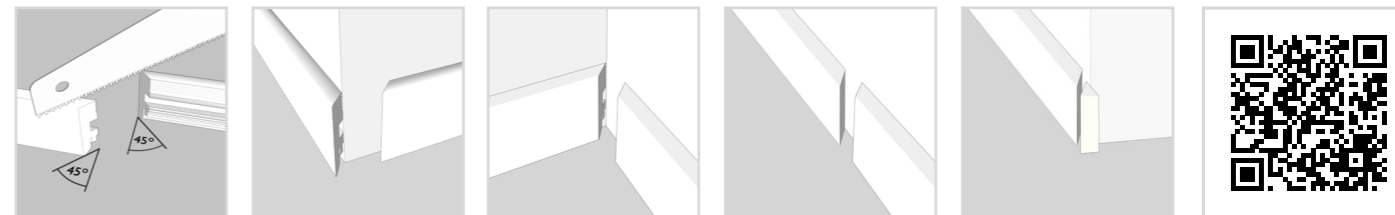

2024.03

The catalogue does not constitute an offer within the meaning of commercial law. Classen Floor Systems Sp z o.o. reserves the right to change and improve the products presented in this publication without prior notice. Information contained in this catalogue is correct at the time of publishing.

Colours presented in this catalogue may differ from the products that are on sale.



@ClassenFloorPoland
@Classen.Group



classen_floor
classen_group



ClassenFloor
Instructions and films



Classen Cloud
Download app with our floors



Classen Competence Centre
Showroom and advice for our customers

www.classenfloor.com

Classen Floor Systems Sp. z o.o.
ul. Wyzwolenia
44-292 Zwonowice, Poland

biuro@classenfloor.pl

CLASSEN Group
Werner-von-Siemens-Str. 18-20
56759 Kaisersesch, Germany

info@classen.de