



SKIRTING BOARDS CATALOGUE

2022

PURE

Classic white MDF skirtings

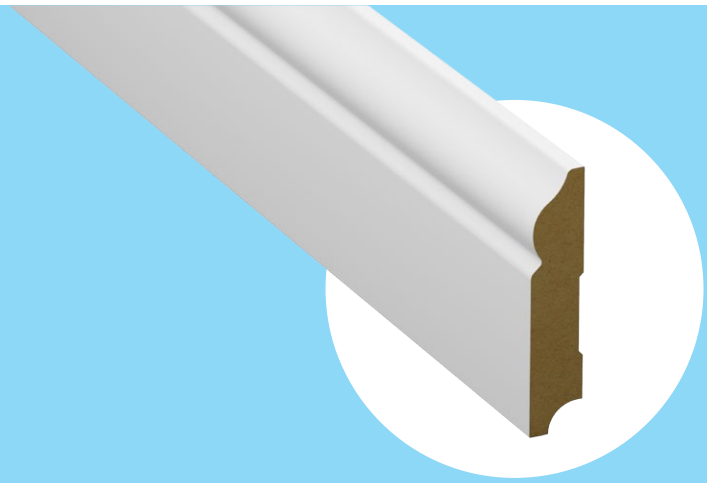

Glue assembly

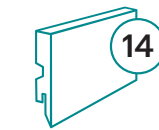

Wide range of profiles

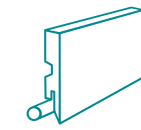

Hidden cabling

80th

Color-matched, waterproof HDF skirtings

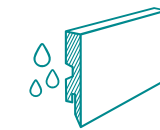

Increased water resistance



Glue assembly

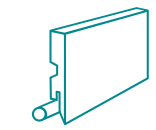

Hidden cabling



82 finishes for laminate flooring

CLIP

Color-matched MDF skirtings

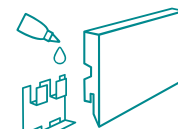

Glue or clip assembly

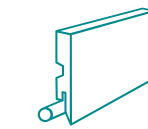

Hidden cabling



Wide range of finishes

PURE

► **Clean and immaculate in itself, perfection and perfect workmanship.**

Subtle, light but also refined. These are Pure strips in its purest form.

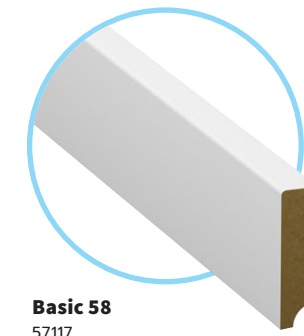

Basic 58
57117

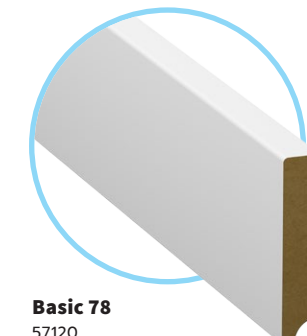

Basic 78
57120

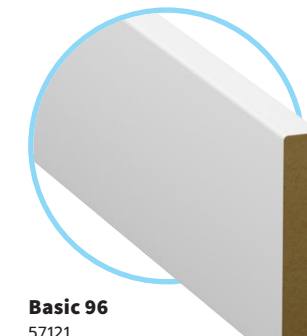

Basic 96
57121

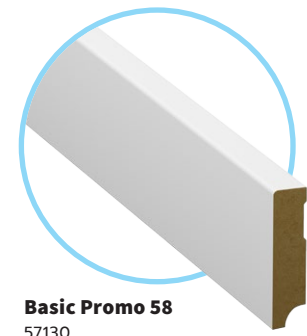

Basic Promo 58
57130

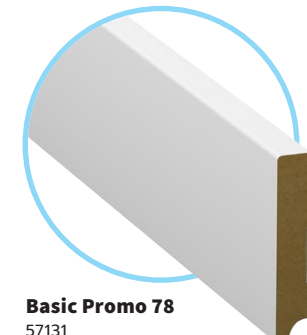

Basic Promo 78
57131

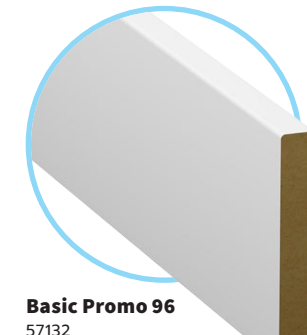

Basic Promo 96
57132

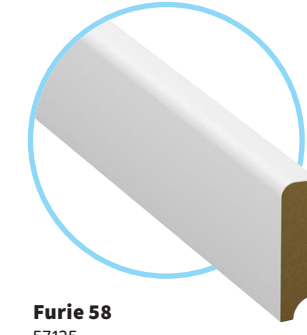

Furie 58
57125

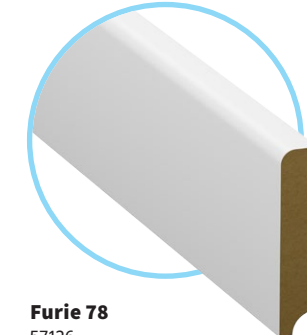

Furie 78
57126

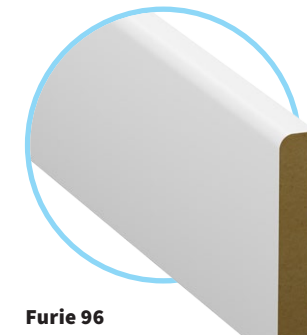

Furie 96
57127

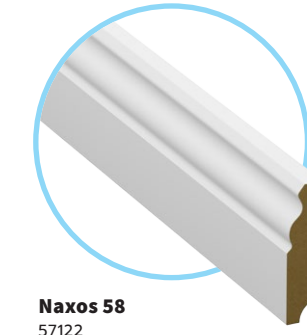

Naxos 58
57122

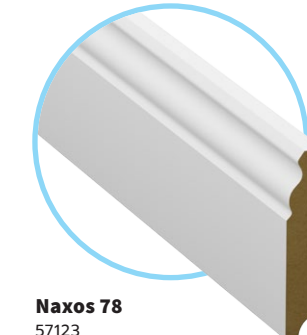

Naxos 78
57123

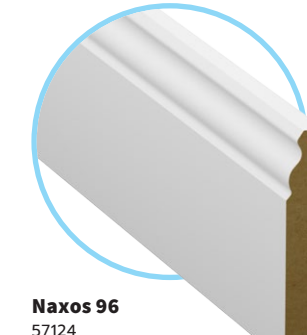

Naxos 96
57124

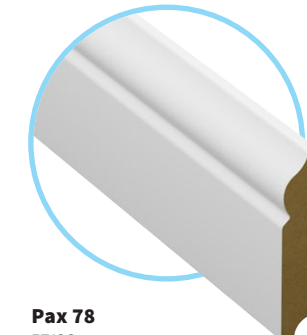

Pax 78
57128

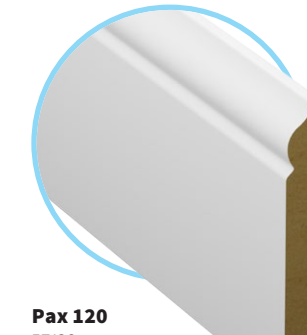

Pax 120
57129

PURE

TECHNICAL DATA

BASIC

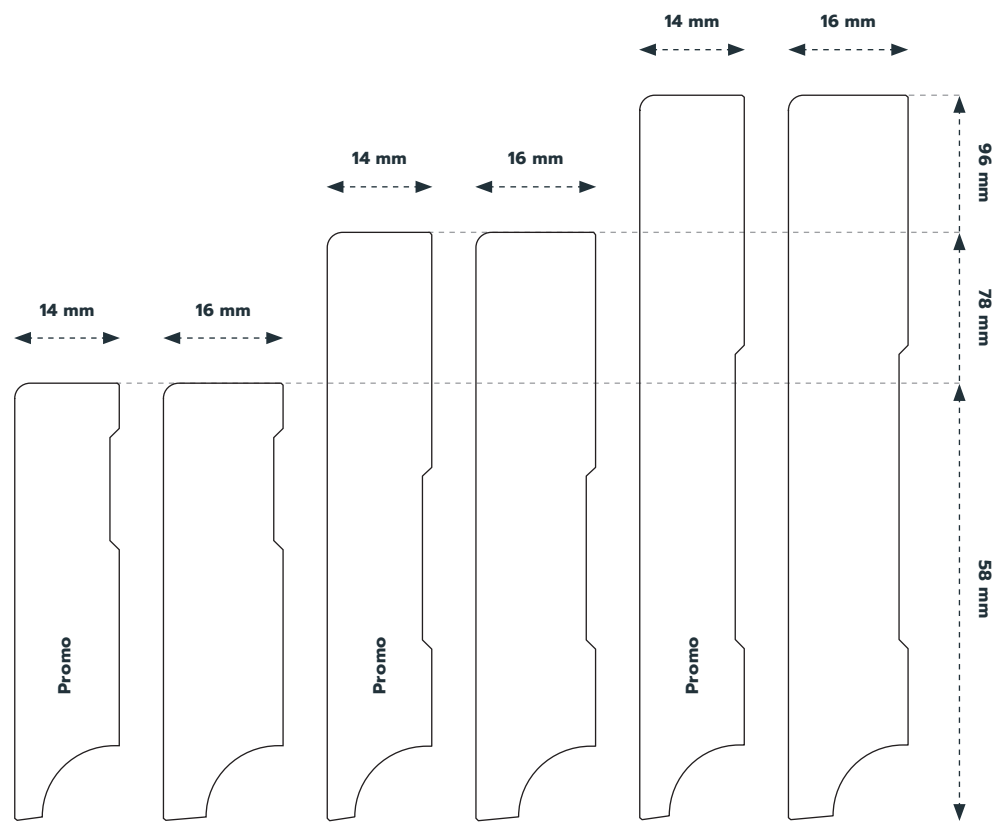

FURIE

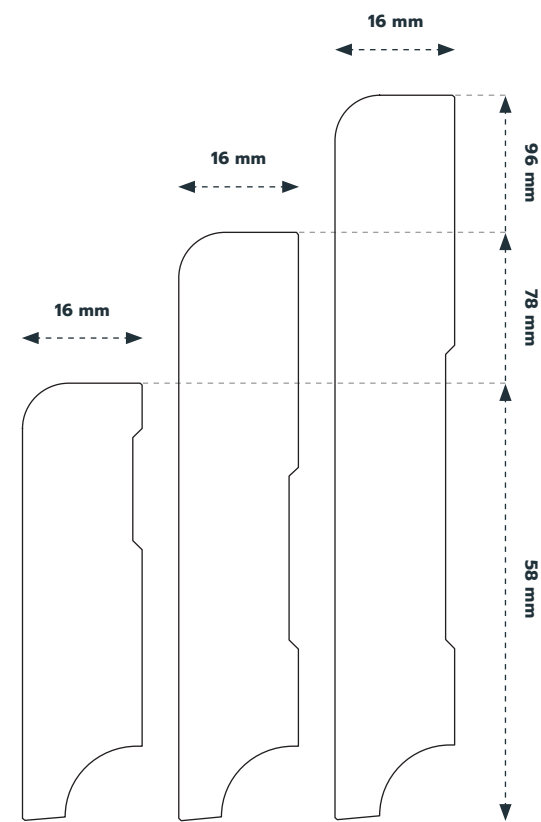

NAXOS

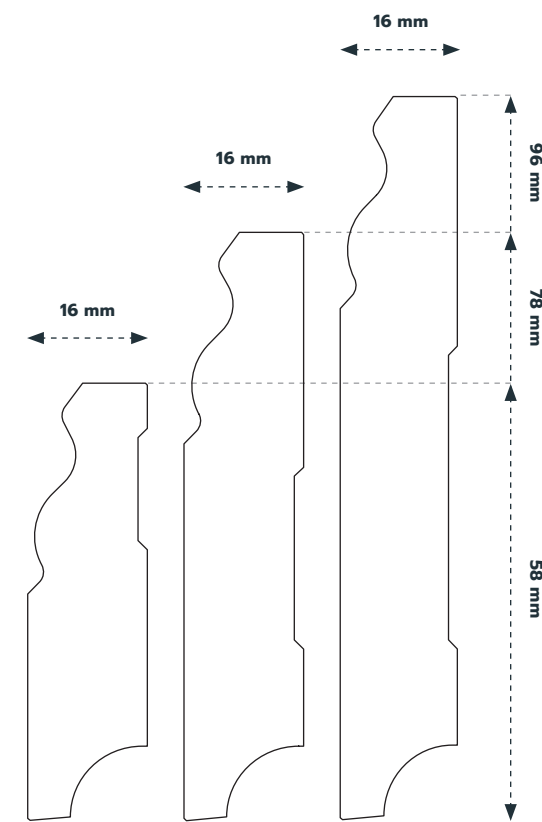

PAX

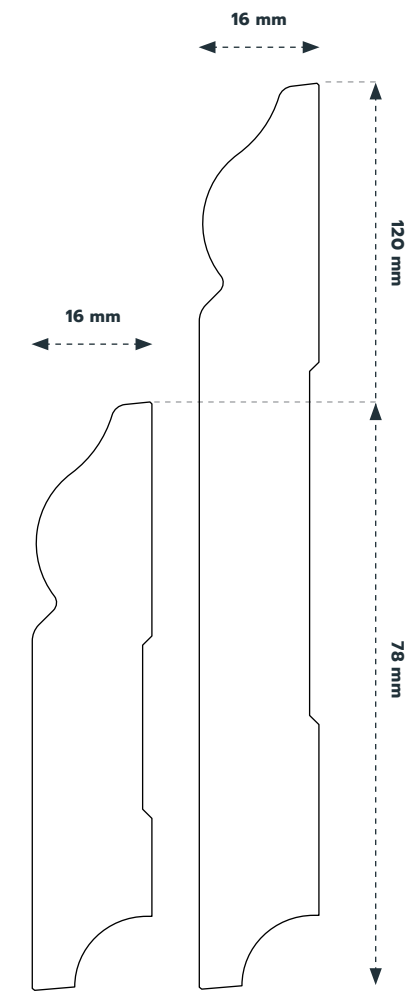

PURE

LOGISTIC DATA

| Index | EAN No. | HEIGHT (mm) | WIDTH (mm) | LENGTH (mm) | NET WEIGHT 1 pcs. (kg) | QUANTITY in package | GROSS WEIGHT package (kg) | QUANTITY on palette | GROSS WEIGHT palette (kg) |
|-------|---------------|-------------|------------|-------------|------------------------|---------------------|---------------------------|---------------------|---------------------------|
| 57117 | 4003992589658 | 58 | 16 | 2400 | 1,10 | 10 | 11,59 | 450 | 588 |
| 57120 | 4003992589627 | 78 | | | 1,65 | 5 | 8,68 | 400 | 719 |
| 57121 | 4003992589634 | 96 | | | 2,31 | 5 | 12,01 | 350 | 866 |
| 57122 | 4003992589665 | 58 | | | 1,10 | 10 | 9,85 | 450 | 468 |
| 57123 | 4003992589641 | 78 | | | 1,62 | 5 | 8,54 | 400 | 709 |
| 57124 | 4003992590531 | 96 | | | 2,15 | 5 | 11,24 | 350 | 812 |
| 57125 | 4003992589672 | 58 | | | 1,10 | 10 | 9,85 | 450 | 468 |
| 57126 | 4003992589696 | 78 | | | 1,82 | 5 | 9,55 | 400 | 789 |
| 57127 | 4003992589689 | 96 | | | 2,27 | 5 | 11,85 | 350 | 854 |
| 57128 | 4003992589702 | 78 | | | 1,57 | 5 | 8,28 | 400 | 688 |
| 57129 | 4003992589719 | 120 | | | 2,64 | 5 | 13,82 | 270 | 771 |
| 57130 | 4003992589726 | 58 | | | 14 | 2400 | 1,00 | 10 | 10,59 |
| 57131 | 4003992589733 | 78 | 1,48 | 5 | | | 12,37 | 448 | 718 |
| 57132 | 4003992589740 | 96 | 2,08 | 6 | | | 12,98 | 396 | 882 |



80TH

➤ A beauty inspired by nature, reflecting the nature of natural wood.

Experience acquired over the years and meticulous work on the selection of colors, such a combination creates the 80TH skirting board in its tasteful and elegant dimension.

 **CLASSEN**



D6110
57566



D6397
57558



D6400
57564



D6401
57552



D6402
57547



D6407
57559



D6419
57551



D6425
57526



D6426
57563



D6427
57546



D6429
57553



D6430
57529



D6431
57557



D6435
57565



D6436
57545



D6438
57554



D6439
57555



D6440
57549



D6441
57562



D6446
57525



L3940
57539



L3941
57541



L3942
57530



L3943
57540



D6448
57533



D6449
57543



D6452
57523



D6453
57528



L3944
57536



L3945
57535



L3986
57560



L3988
57550



L3862
57542



L3891
57524



L3898
57537



L3902
57548



L3991
57556



L3666
57492



L3989
57512



L3882
57485



L3936
57532



L3937
57527



L3938
57534



L3939
57531



L3810
57519



L3682
57498



L3676
57486



D6044
57520



D3637
57513



L3897
57495



L3750
57484



D6283
57501



L3842
57508



L3809
57505



L3863
57509



D6399
57516



L3731
57510



D6148
57500



L881 / L3838
57497



L3670
57506



L3655
57499



L3751
57522



L733
57488



L738
57493



L3672
57494



L3667
57496



D6005
57514



L3905
57515



L740
57491

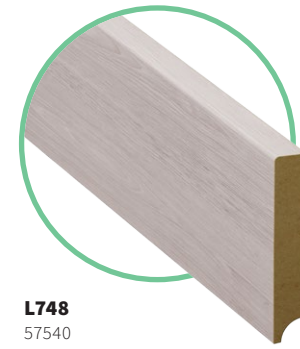

L748
57540



L3672
57494



L3675
57517



D6398
57511



L3674
57490



L3794
57489

80TH

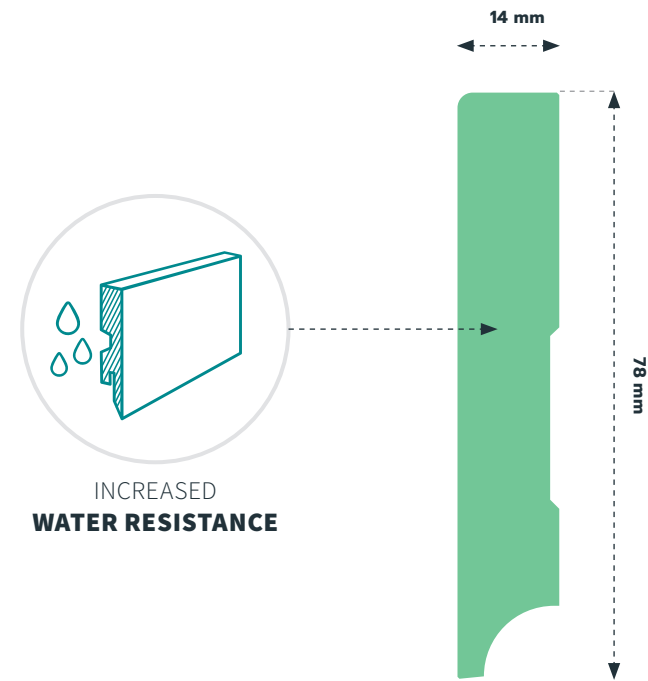

TECHNICAL DATA

LOGISTIC DATA

|  | HEIGHT (mm) | WIDTH (mm) | LENGTH (mm) | NET WEIGHT 1 pcs. (kg) | QUANTITY in package | GROSS WEIGHT package (kg) | QUANTITY on palette | GROSS WEIGHT palette (kg) |
|---|-------------|------------|-------------|------------------------|---------------------|---------------------------|---------------------|---------------------------|
| | 78 | 14 | 2400 | 1,81 | 5 | 9,43 | 405 | 789 |



CLIP

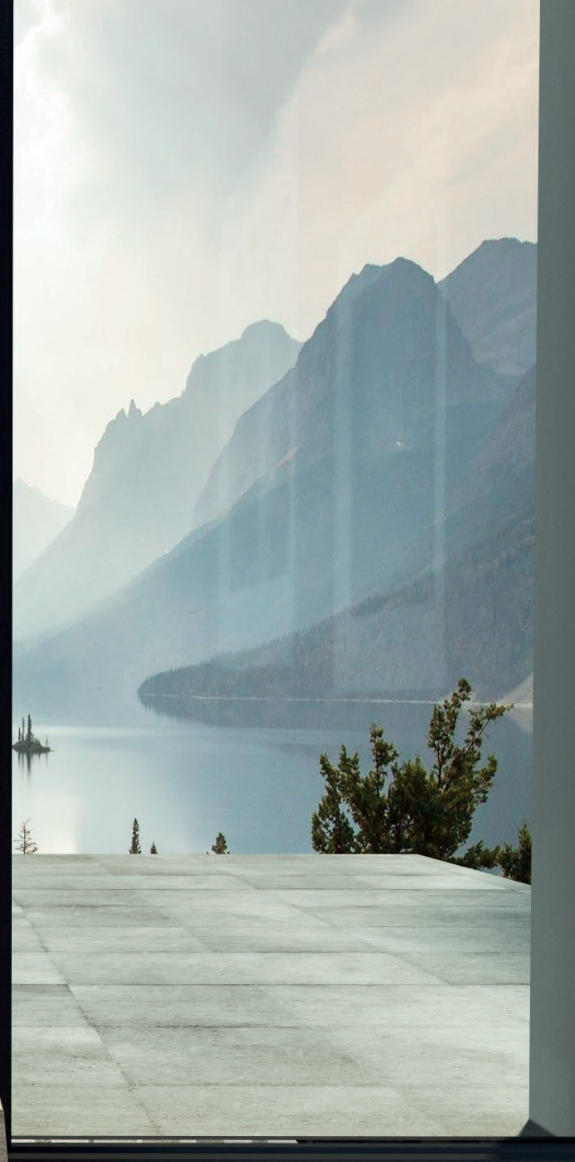

Clip is a strip which owes its universal character to its shape and color.

A combination of tradition and modernity that will add style to any interior.



L254
57204



L264
57205



L572
57206



L845
45566



L373
57207



L278
32516



L530
33044



L3731
42822



L848
57208



L412
57209



L3674
57210



D379
33043



D575
57211



L1038
57212



L520
57213



D378
42817



L664
57215



L301
57216



L3638
57217



L3739
57218



L240
42832



D6005
36345



L3655
57219



L782
57220



L3658
57221



L3637
57222



L663
57223



White
31832



L3635
57224



L512
32511



D3637
57225

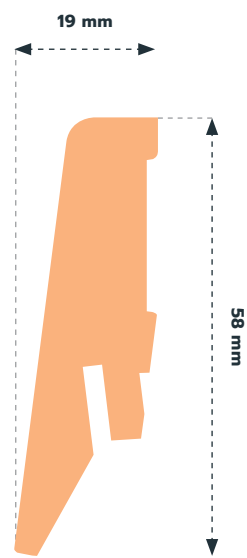

TECHNICAL DATA

LOGISTIC DATA

|  | HEIGHT (mm) | WIDTH (mm) | LENGTH (mm) | NET WEIGHT 1 pcs. (kg) | QUANTITY in package | GROSS WEIGHT package (kg) | QUANTITY on palette | GROSS WEIGHT palette (kg) |
|---|-------------|------------|-------------|------------------------|---------------------|---------------------------|---------------------|---------------------------|
| | 58 | 19 | 2400 | 0,98 | 10 | 10,49 | 540 | 591 |

UNDERLAY FOR LAMINATES AND WOODEN FLOORS

2 mm Thermo > 500 x 1000 x 2 mm



For heated floors



Simple to fix



Levelling of the base



Acoustic insulation

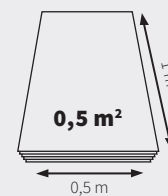

| | HEIGHT (mm) | WIDTH (mm) | LENGTH (mm) | NET WEIGHT 1 pcs. (kg) | QUANTITY in package | GROSS WEIGHT package (kg) | QUANTITY on palette | GROSS WEIGHT palette (kg) |
|-------|-------------|------------|-------------|------------------------|---------------------|---------------------------|---------------------|---------------------------|
| 57147 | 2 | 500 | 1000 | 0,08 | 136 | 10,88 | 1088 | 87 |

UNDERLAY FOR LAMINATES AND WOODEN FLOORS

3 mm & 5 mm > 500 x 1000 x 3 / 5 mm



Thermal insulation



Simple to fix



Levelling of the base



Acoustic insulation

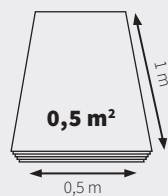

| | HEIGHT (mm) | WIDTH (mm) | LENGTH (mm) | NET WEIGHT 1 pcs. (kg) | QUANTITY in package | GROSS WEIGHT package (kg) | QUANTITY on palette | GROSS WEIGHT palette (kg) |
|-------|-------------|------------|-------------|------------------------|---------------------|---------------------------|---------------------|---------------------------|
| 57148 | 3 | 500 | 1000 | 0,09 | 95 | 8,55 | 760 | 68 |
| 57149 | 5 | 500 | 1000 | 0,15 | 60 | 9,00 | 480 | 72 |

NEO Lay > 10000 x 1000 x 1,5 mm



For heated floors



Simple to fix



Levelling of the base



Acoustic insulation

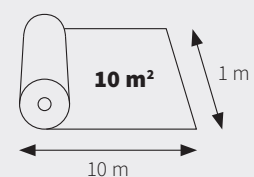

| | HEIGHT (mm) | WIDTH (mm) | LENGTH (mm) | NET WEIGHT 1 pcs. (kg) | QUANTITY in package | GROSS WEIGHT package (kg) | QUANTITY on palette | GROSS WEIGHT palette (kg) |
|-------|-------------|------------|-------------|------------------------|---------------------|---------------------------|---------------------|---------------------------|
| 38626 | 1,5 | 1000 | 10000 | 1,35 | 10 | 13,50 | 400 | 540 |

Mounting accessories



44944

Classen Multi-Connect glue
15 kg



43351

Glue spreader
B1 180 mm



43347

Ceramin finishing profile
3 x 2500 mm



44945

Classen Multi-Connect glue
5,5 kg



43352

Glue spreader
B3 180 mm



57429

Dilatation string
6 mm / 10 mb.



44946

Classen Multi-Connect glue
Tube 290 ml



43353

Glue spreader
C1 180 mm



57431

Dilatation string
10 mm / 12 mb.

The catalogue does not constitute an offer within the meaning of commercial law.

Classen Floor Systems Sp z o.o. reserves the right to change and improve the products presented in this publication without prior notice. Information contained in this catalogue is correct at the time of publishing.

Colours presented in this catalogue may differ from the products that are on sale.



Classen Floor Systems Sp. z o.o.
ul. Wyzwolenia
44-292 Zwonowice k. Rybnika, Poland

tel.: +48 (32) 429 20 00
biuro@classenfloor.pl

www.classenfloor.com